

335-0325 3/8" ID Hose, Synthetic Rubber, High Temp Oil Transmission



Ⓢ

NOTES:

1) VENDOR DATA:

ACCEPTED SOURCE: VEYANCE TECHNOLOGIES, INC.
MATERIAL REFERENCE #: 1016 TOC (ON A REEL)
DESCRIPTION: SAE J1532 HOSE, 9.5mm I.D., BLACK COVER

2) SPECIFICATIONS:

HOSE TO MEET ALL REQUIREMENTS OF SAE J1532 TYPE A, CLASS 2.

- A) MAX OPERATING PRESSURE: 250 psi
- B) OPERATING TEMPERATURE: -40°F TO 302°F
- C) MIN BEND RADIUS: 1.6 in. (SEE DIAGRAM)

EXCEPTIONS:

- A) MINIMUM IMPULSE CYCLES: 150,000 (REF. SAE J1532 SECTION 5.5)
- B) OPTIONAL LAYLINE (IDENTIFICATION MARKING): AS REQUIRED BY GENERAL MOTORS FOR THIS PRODUCT.

3) CONSTRUCTION:

- A) INNER TUBE: OIL RESISTANT SYNTHETIC RUBBER TUBE (CHLORINATED POLYETHYLENE)
- B) REINFORCEMENT BRAID: YARN OR TEXTILE BRAID (POLYESTER BRAID)
- C) COVER: OIL & WEATHER RESISTANT SYNTHETIC RUBBER COVER (CHLORINATED POLYETHYLENE - BLACK)

4) CONCENTRICITY REQUIREMENT: .031" I.D.-TO-O.D. MAX

5) ALL HOSE DISCONTINUITIES MUST BE CLEARLY MARKED.

6) HOSE CERTIFICATIONS ARE REQUIRED FROM SUPPLIER PER LOT.



335-0515 3/8" ID Hose, Red Ultragrip

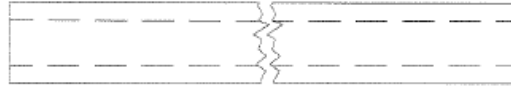
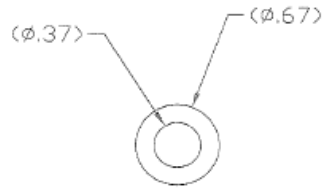

APPROVED SUPPLIER:

GOODYEAR ENGINEERED PRODUCTS

GOODYEAR MATERIAL #: 20022772

PRODUCT CODE: 53528901200400

DESCRIPTION: 3/8" ULTRA-GRIP / RED

NOTES:

1) COVER MUST BE CARBRYN

3/4" ID Hose, Red Ultragrip

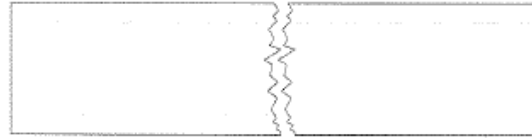
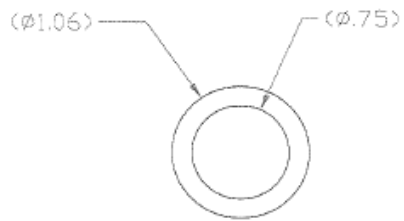

APPROVED SUPPLIER:
GOODYEAR ENGINEERED PRODUCTS
GOODYEAR MATERIAL #: 20022779
PRODUCT CODE: 53528902400200
DESCRIPTION=3/4" ULTRA-GRIP / RED

NOTES:
1) COVER MUST BE CARBRYN

335-3075 5/8" Polyester Braid Hose, Polyethelene Cover

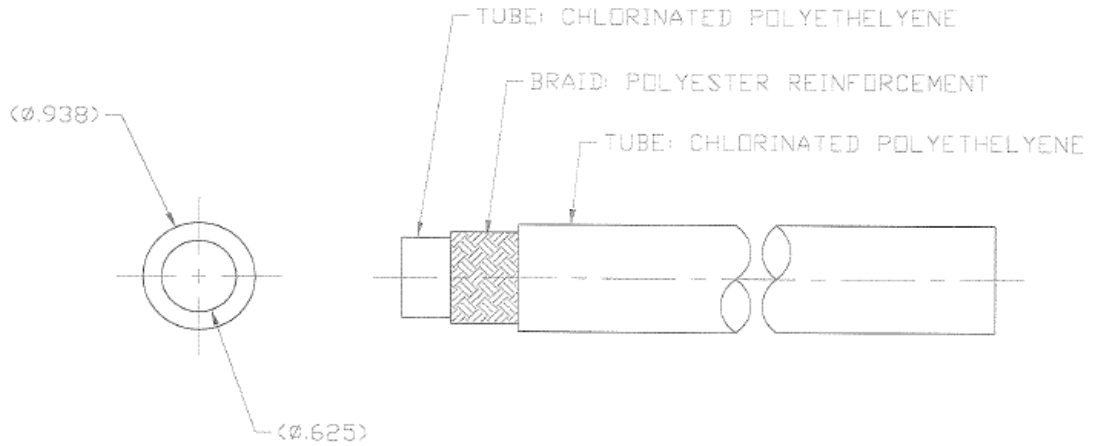

APPROVED SUPPLIER: GOODYEAR
P/N# 20137755

NOTES:

1. MAXIMUM OPERATING TEMP: +275°F
2. 28Hg VACUUM RESISTANCE
3. MINIMUM BURST PRESSURE: 800 PSI
4. 200 PSI MIN. WORKING PRESSURE
5. HOSE COVERING MUST BE BLACK IN COLOR

336-0045 5/8" Hose, SAE 30R7



Ⓢ

NOTES:

1) VENDOR DATA:

ACCEPTED SOURCE: GOODYEAR (OR EQUIVALENT)
MATERIAL REFERENCE #: 580 019
DESCRIPTION: SAE 30R7 (5/8 I.D.)

2) CONSTRUCTION:

A) TEMPERATURE: UP TO 257°F
B) MIN. BURST OF 175 psi

3) HOSE CERTIFICATIONS ARE REQUIRED FROM SUPPLIER PER LOT.

336-0376 3/4" Paint Suc. Hose, Grey, Pre-Cut 30" lgth

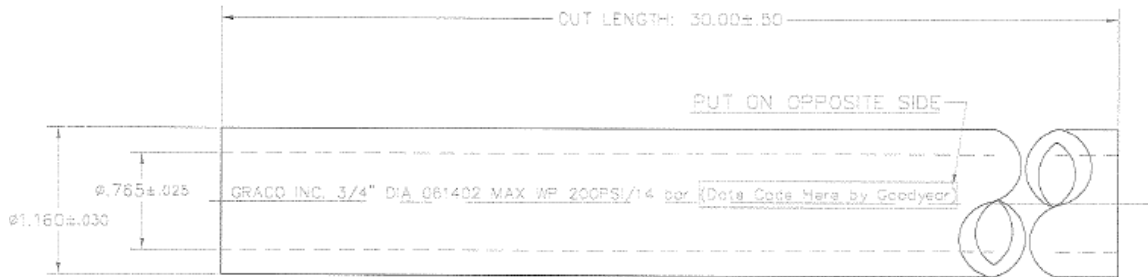

APPROVED SUPPLIER:

GOODYEAR

PART #:

DESCRIPTION:

SMOOTH NYLON TUBE
GRAY NITRILE COVER
SINGLE BRAID SYNTHETIC FIBER REINFORCEMENT
HOLD FULL VACUUM WITHOUT COLLAPSE
WORKING PRESSURE: 200 PSI,
BURST PRESSURE: 600 PSI,
BEND RADIUS: 4 INCHES WITHOUT KINKING
HOSE LAYLINE MUST BE IN WHITE LETTERING

336-0386 Bulk Fluid Hose GRACO 1.0 DIA

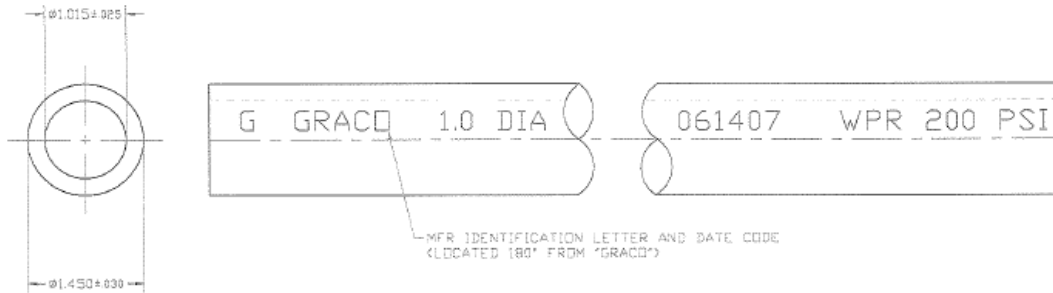

APPROVED SUPPLIER: GOODYEAR
P/N #536590032

NOTES:

1. TUBE: SMOOTH NYLON
REINFORCEMENT: SINGLE BRAID SYNTHETIC FIBER
COVER: BLACK NEOPRENE
2. WORKING PRESSURE: 200 PSI
BURST PRESSURE: 800 PSI MINIMUM
BEND RADIUS: 5.00" MINIMUM WITHOUT KINKING
3. HOSE MUST BE LABELED AS SHOWN AND BE VISIBLE EVERY 12'

336-0387 Hose, Paint, 1" Nylon/Rubber

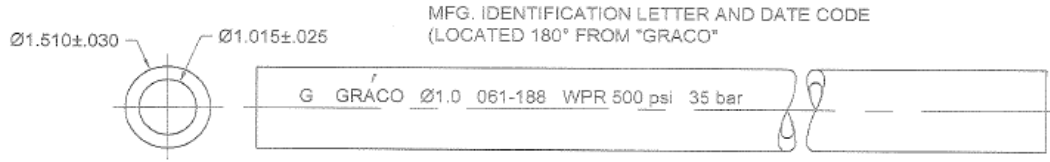

NOTES:

- 1) **VENDOR DATA:**
 - ACCEPTED SOURCE: GOODYEAR INDUSTRIAL HOSE
 - PART#: 20222096
 - REFERENCE #: 536-290-032
 - DESCRIPTION: 1" NYLON/RUBBER PAINT SPRAY HOSE
- 2) **SPECIFICATIONS:**
 - TEMPERATURE RANGE: 0°F TO 190°F
 - WORKING PRESSURE: 750 psi MAX.
 - BURST PRESSURE: 3000 psi MIN.
 - HOSE MUST BE LABELED AS SHOWN AND BE VISIBLE EVERY 12 in.
- 3) **CONSTRUCTION:**
 - A) INNER TUBE: SMOOTH NYLON
 - B) REINFORCEMENT BRAID: DOUBLE BRAID SYNTHETIC FIBER
 - C) COVER: BLACK NEOPRENE
- 4) HOSE CERTIFICATIONS ARE REQUIRED FROM SUPPLIER PER LOT.